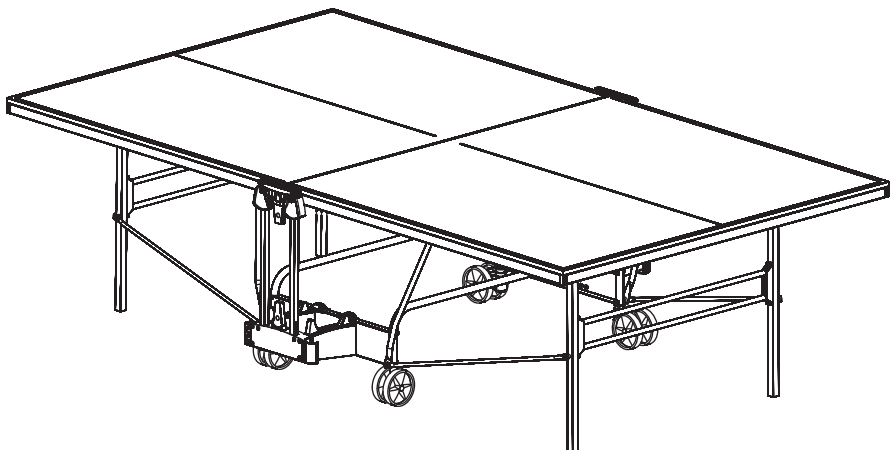

D**Montage- und Bedienungsanleitung****D****GB****Instructions for Assembly and Use****GB****F****Instructions de montage et d'utilisation****F****E****Instrucciones para el manejo y uso****E****RUS****Инструкция по монтажу и эксплуатации****RUS****I****Istruzioni per il montaggio e per l'uso****I****H****Szerelési és kezelési útmutató****H****CZ****Návod k sestavení a použití****CZ****YouTube**

Smartphone Scan:

YouTube channel: www.youtube.com/ttserviceVideo URL: <http://youtu.be/XS9BqtrUAvY>**MA 233 - v.08.08.12-03**

D

Vor der Montage und der ersten Benutzung lesen Sie bitte die Montageanleitung und die Benutzerinformationen sorgfältig durch. Sie erhalten wichtige Hinweise für Ihre Sicherheit beim Gebrauch des TT-Tisches. Bewahren Sie die Anleitungen zu Ihrer Information, Instandhaltung und Ersatzteilbestellung auf, solange Sie den TT-Tisch nutzen.

- Montieren Sie den TT-Tisch mit mindestens **2 erwachsenen Personen** auf einer sauberen und weichen Unterlage.
- Verwenden Sie für den Montageschritt den entsprechenden **Montagebeutel**.
- Folgen Sie bei der Montage der angegebenen Reihenfolge der Montageschritte: A, B, C, ... usw.
- Lesen Sie bei **Textmarken** die Erklärungen auf Seite **III**.
- Orientieren Sie sich bei **Teilemarken** anhand der Teileliste auf Seite **V**.
- Verwenden Sie die bei den Montageschritten angegebenen **Werkzeuge**.

Montagebeutel



Textmarke



Teilemarke

13

Werkzeug

**GB**

Before starting to assemble the tt-table and before using it for the first time please read the Assembly Instructions and the Information for the User very carefully. They contain important advices for safety when using the table. Please keep the instructions for your information, for maintenance and for ordering spare parts as long as you use the tt-table.

- At least **two adults** have to participate in the assembly of the tt-table which should be carried out on a clean and soft floor.
- Use corresponding **assembly kit** for this installation step.
- Please follow the ABC references for the order of the assembly.
- If there is a **text mark**, please read the explanation on page **III**.
- If there is a **part mark**, please read the information relating to it in the Parts List on page **V**.
- Please use the **tools** as indicated for each of the assembly stages.

Assembly kit



Text mark



Part mark

13

Tool

**F**

Avant le montage et la première utilisation de la table de ping-pong, lire attentivement les instructions de montage et d'utilisation. Elles comportent des renseignements importants pour votre sécurité sur l'utilisation de la table de ping-pong. Veuillez conserver ces instructions pour votre information, pour l'entretien et la commande de pièces détachées, tant que vous utiliserez la table de ping-pong.

- Le montage de la table de ping-pong nécessite l'intervention de **deux adultes** au moins et doit avoir lieu sur une surface propre et sans aspérités.
- Utilisez le **sachet de montage** correspondant pour la phase de montage.
- Veuillez suivre, lors du montage de la table de ping-pong, les instructions de montage dans l'ordre indiqué : A, B, C, ... etc.
- Les explications des **symboles** se trouvent en page **III**.
- Le détail de la **numérotation** des pièces figure en page **V**.
- Veuillez utiliser les **outils** indiqués pour les différentes étapes du montage.

Sachet de montage



Symboles



Numérotation

13

Outils

**E**

Antes de empezar a montar la mesa, y antes de usarla por primera vez, por favor leer las instrucciones de manejo y la información para el uso muy cuidadoso. Contienen avisos importantes de seguridad para el uso la mesa. Por favor sigue las instrucciones para tu información, para el mantenimiento y para ordenar las partes de más, a lo largo del uso de mesa.

- Cuando **dos adultos** tengan que montar la mesa, deberían llevarlo a cabo en un suelo limpio, y blando.
- Emplee para esta fase del montaje la **bolsa de montaje** correspondiente.
- Sigue las instrucciones de las referencias ABC, para el orden del montaje.
- Si hay una **nota en el texto**, lee la explicación de la página **III**.
- Si hay una **marca a parte**, lee la información relacionada con ella, en la lista en la página **V**.
- Utiliza las **herramientas** como indicamos para cada etapa del manejo.

bolsa de montaje



nota en el texto



marca a parte

13

herramienta



RUS

Перед монтажом и перед первым использованием стола внимательно прочтите инструкцию по монтажу и информацию для пользователя. Вы получите важные сведения и указания по безопасности использования стола для настольного тенниса. Инструкцию сохраняйте в течение всего времени эксплуатации стола.

- Монтаж стола для настольного тенниса должен производиться минимально **двумя взрослыми лицами** на чистой и мягкой подкладке.
- Для монтажа используйте специальный **монтажный набор**.
- Монтаж проводите шаг за шагом согласно заданной последовательности: А, В, С, ... и т. д.
- Объяснения **пометок в тексте** читайте на стр. **IV**.
- Для ориентирования в **маркировочных знаках** используйте спецификацию частей на стр. **V**.
- Используйте для каждого монтажного шага только указанные **инструменты**.

монтажный набор



Пометка в тексте



Маркировочные знаки

13

Инструмент



I

Si prega di leggere attentamente le istruzioni di montaggio prima di usare l'attrezzo. Seguire attentamente le norme di sicurezza che sono importanti nell'uso del tavolo da ping pong. Fino a quando userete il tavolo da ping pong, è consigliabile conservare le istruzioni sia a titolo informativo sia nel caso di eventuali riparazioni e/o ordini di pezzi di ricambio.

- Eseguire il montaggio del tavolo da ping pong con l'aiuto almeno di **2 persone adulte** poggiandolo su un piano pulito e soffice
- Utilizzi per il passo di montaggio il corrispondente **sacchetto di montaggio**.
- Seguire in fase di montaggio la successione indicata delle fasi di montaggio: А, В, С, ... ecc.
- Leggere nelle **etichette di testo** le spiegazioni a pagina **IV**.
- Orientarsi nelle **etichette dei componenti** secondo la distinta base presente a pagina **V**.
- Usare nelle fasi di montaggio gli **attrezzi** indicati.

sacchetto di montaggio



Etichetta di testo



Etichetta die componenti

13

Attrezzo



H

A szerelés és az első használat előtt tanulmányozzák át gondosan a szerelési útmutatót és a felhasználó számára szolgáló tájékoztatásokat. Ezek a pingpongasztal használatával kapcsolatos, a személyes biztonságot szolgáló fontos tudnivalókat tartalmaznak. A tájékozódáshoz, karbantartáshoz és alkatrészrendeléshez szükséges dokumentációt őrizzük meg mindaddig, amíg a pingpongasztalt használjuk.

- A pingpongasztal tiszta és puha alapra történő felállításához legalább 2 felnőtt személyre van szükség.
- Használja az **összeszereléshez** a megfelelő **összeszerelési csomagot**.
- A szerelés során a megadott sorrendben végezzük el az egyes műveleteket (A, B, C ... stb.).
- A **szövegben** szereplő **jelzések** magyarázatát lásd a **IV**. oldalon.
- Az egyes részek jelöléseinek történő eligazodáshoz a **V**. oldalon található **alkatrészjegyzék** nyújt segítséget.
- A szerelési műveleteket a megadott **szerszámokkal** végezzük el.

összeszerelési csomagot



Szöveges jelzés



Alkatrész-jelzés

13

Szerszám



CZ

Před prvním použitím si prosím přečtěte pozorně návod k použití. Instrukce obsahují důležité body týkající se bezpečnosti při používání pinpongového stolu. Prosím, uchovejte návod k použití co nejdéle pro vaši informovanost, sestavení a objednání náhradních dílů.

- Sestavení pinpongového stolu za pomoci minimálně dvou dospělých osob na čistém a měkkém povrchu.
- Použijte pro tento montážní krok odpovídající **montážní sáček**.
- Při samotném sestavování pinpongového stolu dodržujte prosím postup: А, В, С, ... atd. tak, jak je uvedeno v návodu.
- V případě jakékoliv **značky v textu** si prosím přečtěte instrukce na str. **IV**.
- V případě jakékoliv části **dílů** se prosím informujte na str. **V** seznam dílů.
- Použijte uvedené **nářadí** s odlišným postupem použití.

montážní sáček



textová značka









značka dílu

13







nářadí









D**Textmarken für die Montage**

-  • Muttern bei Sicherungselement **17** nicht zu fest anziehen, damit sich das rote Teil leicht bewegt.
-  • Mutter **11** nicht zu fest anziehen, damit sich der Tisch noch leicht auf- und zusammenklappen lässt.
-  • Gehen Sie zurück zu Schritt "A" und montieren Sie die 2. Plattenhälfte.
-  • Gehen Sie zurück zu Schritt "E" und montieren Sie die 2. Plattenhälfte.
-  • Gehen Sie zurück zu Schritt "G" und montieren Sie die 2. Plattenhälfte.
-  • Gehen Sie zurück zu Schritt "J" und montieren Sie die 2. Plattenhälfte.
-  • Führen Sie nach der Montage eine Funktionsüberprüfung gemäß der Bedienungsanleitung durch und entfernen Sie, falls notwendig, vorsichtig die Schutzfolie von der Spieloberfläche.







GB**Text marks for the assembly**

-  • Do not over tighten the nuts of the safety unit **17** so that the red part can still move easily.
-  • Please do not over tighten the nut **11** so that the tt-table can still be folded and unfolded easily.
-  • Go back to step "A" and assemble the second table top.
-  • Go back to step "E" and assemble the second table top.
-  • Go back to step "G" and assemble the second table top.
-  • Go back to step "J" and assemble the second table top.
-  • Please check all the working parts of the table in accordance with the Instructions for use after you have completed assembly. If applicable please take care when removing the coating from the playing surface.







F**Symboles**

-  • Ne pas trop visser les écrous du dispositif de sécurité **17**, afin que la partie rouge puisse bouger facilement.
-  • Veuillez ne pas visser trop fort l'écrou **11**, afin que la table de ping-pong puisse être ouverte et repliée aisément.
-  • Retournez à l'étape "A" et montez le second plateau.
-  • Retournez à l'étape "E" et montez le second plateau.
-  • Retournez à l'étape "G" et montez le second plateau.
-  • Retournez à l'étape "J" et montez le second plateau.
-  • Veuillez, après le montage, vérifier le bon fonctionnement de la table de ping-pong, conformément aux instructions d'utilisation, et enlever avec précaution, s'il y en a un, le film protecteur de la surface de jeu.







E**Pasos de montaje**

-  • No apretar por encima las tuercas de la unidad **17** de seguridad, ya que la parte roja puede permanecer moviéndose fácilmente.
-  • No apretes la tuerca **11**, ya que la mesa puede permanecer plegada, y desplegarse fácilmente.
-  • Vuelve al paso "A", y ensambla la segunda parte de la mesa.
-  • Vuelve al paso "E", y ensambla la segunda parte de la mesa.
-  • Vuelve al paso "G", y ensambla la segunda parte de la mesa.
-  • Vuelve al paso "J", y ensambla la segunda parte de la mesa.
-  • Por favor revise todas las funciones de acuerdo con las instrucciones de montaje, después de haber montado la mesa. Quite cuidadosamente la capa de protección de la parte superior si es necesario.







RUS**Пометки в тексте для монтажа**

-  • Не затягивайте до отказа гайку на предохранительном элементе **17**, красная часть должна быть слегка подвижной.
-  • Чтобы стол легко раскладывался и складывался, не затягивайте до отказа гайку **11**.
-  • Вернитесь к монтажному действию "А" и соберите 2-ю половину плиты стола.
-  • Вернитесь к монтажному действию "Е" и соберите 2-ю половину плиты стола.
-  • Вернитесь к монтажному действию "G" и соберите 2-ю половину плиты стола.
-  • Вернитесь к монтажному действию "J" и соберите 2-ю половину плиты стола.
-  • После монтажа проведите проверочное испытание на функциональность стола, согласно инструкции по эксплуатации и, при необходимости, удалите защитную плёнку с игровой поверхности.







I**Etichette di testo per il montaggio**

-  • Non serrare eccessivamente i dadi nell'elemento di sicurezza **17** in modo che la parte rossa possa muoversi liberamente.
-  • Non serrare eccessivamente il dado **11**, in modo che il tavolo possa aprirsi e chiudersi facilmente.
-  • Tornare alla fase "A" e montare la seconda metà della tavola.
-  • Tornare alla fase "E" e montare la seconda metà della tavola.
-  • Tornare alla fase "G" e montare la seconda metà della tavola.
-  • Tornare alla fase "J" e montare la seconda metà della tavola.
-  • Una volta conclusa la fase di montaggio, verificare se funziona secondo quanto indicato nel manuale d'uso e rimuovere, se necessario, attentamente la pellicola di protezione dalla superficie di gioco.

H**A szereléssel kapcsolatos szöveges jelzések**

-  • A **17** biztosító elem anyáit ne húzzuk meg túl erősen, hogy a piros elemet könnyen mozgatni lehessen.
-  • A **11** anyát ne húzzuk meg túl szorosan, hogy az asztal könnyen föl lehessen állítani és össze lehessen hajtani.
-  • Térjünk vissza a "A" művelethez, és szereljük fel a 2. fél asztallapot.
-  • Térjünk vissza a "E" művelethez, és szereljük fel a 2. fél asztallapot.
-  • Térjünk vissza a "G" művelethez, és szereljük fel a 2. fél asztallapot.
-  • Térjünk vissza a "J" művelethez, és szereljük fel a 2. fél asztallapot.
-  • A szerelés befejezését követően ellenőrizzük a működést a kezelési útmutatóban előírtaknak megfelelően, azután amennyiben szükséges távolítsuk el a védőfóliát a játszó-felületről.

CZ**Textové značky pro sestavení**

-  • Neutahujte příliš matice pojistné části **17**; červená část se musí lehce pohybovat.
-  • Prosím neutahujte příliš matici **11**; pinpongový stůl by měl být snadno složitelný a rozložitelný
-  • Vraťte se ke kroku "A" a sestavte druhou vrchní část stolu.
-  • Vraťte se ke kroku "E" a sestavte druhou vrchní část stolu.
-  • Vraťte se ke kroku "G" a sestavte druhou vrchní část stolu.
-  • Vraťte se ke kroku "J" a sestavte druhou vrchní část stolu.
-  • Po montáži provedte zkoušku funkčnosti a odstraňte, když je to nutné, opatrně ochrannou fólii z vrchní desky pinpongového stolu.

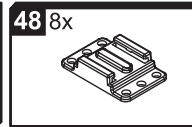
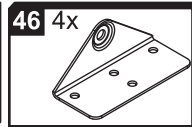
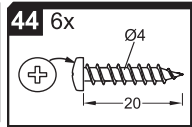
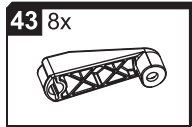
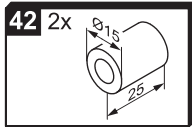
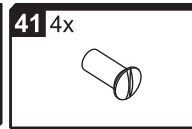
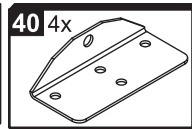
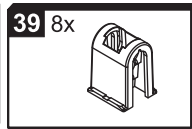
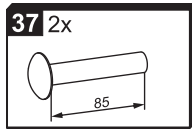
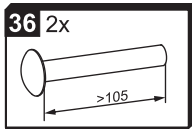
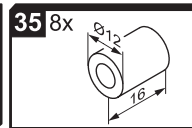
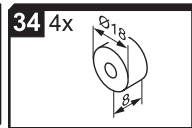
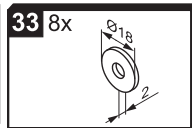
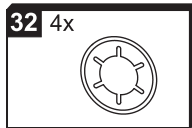
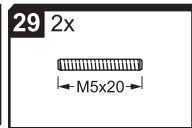
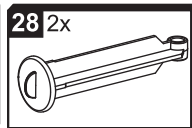
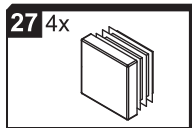
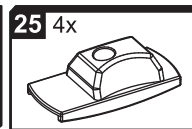
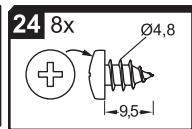
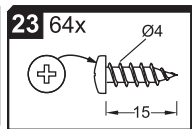
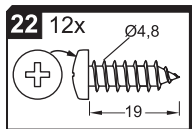
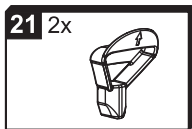
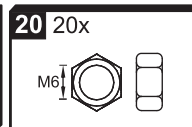
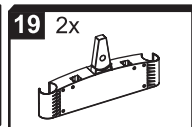
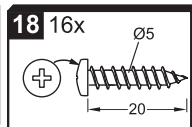
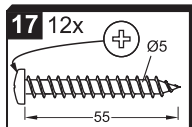
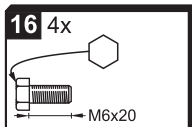
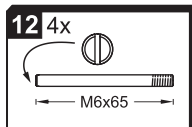
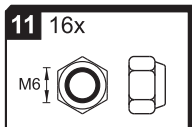
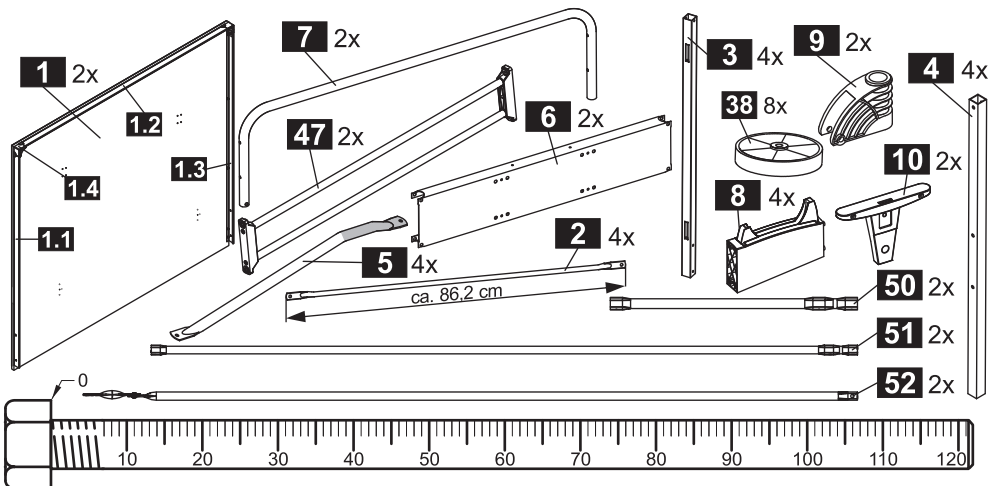

A

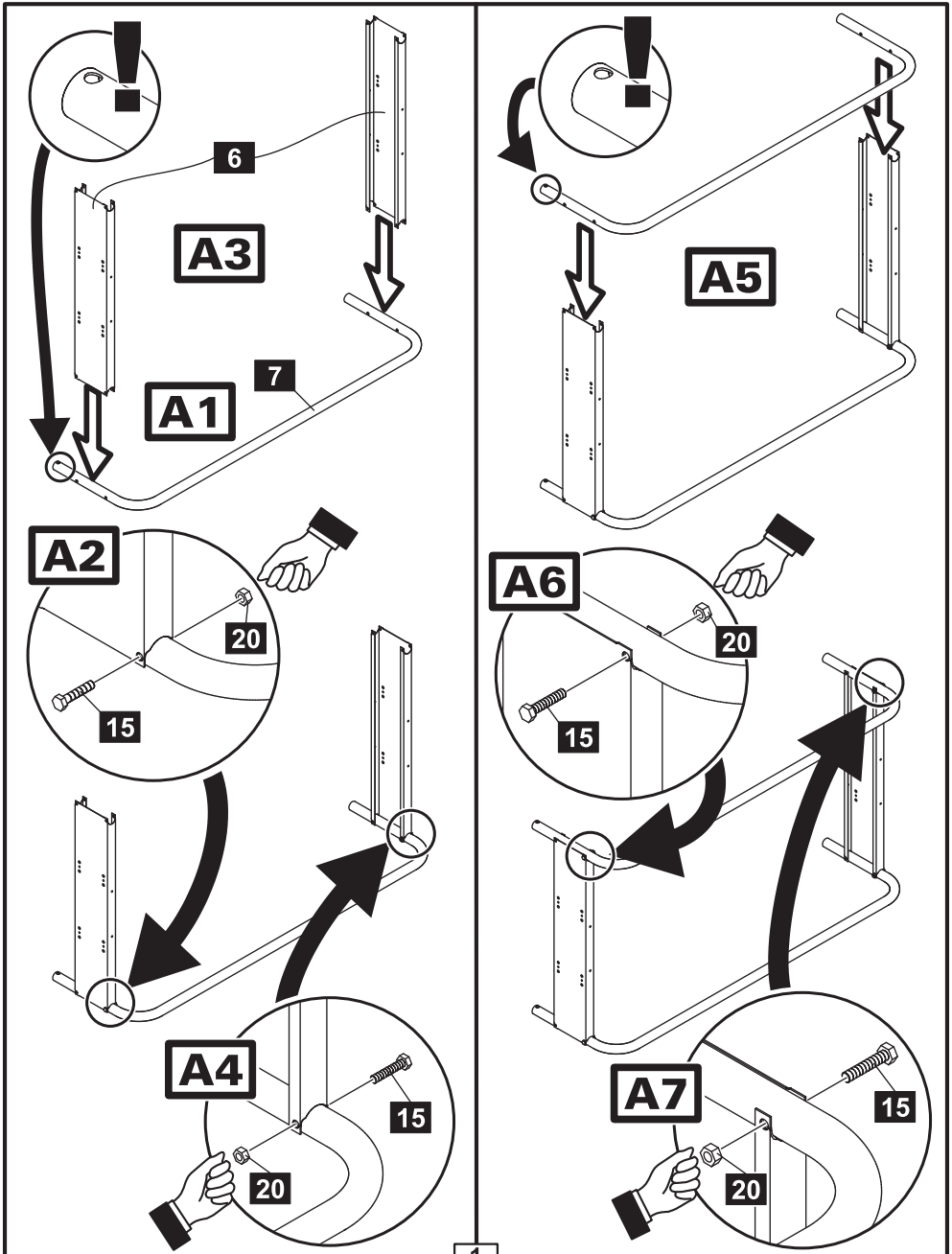

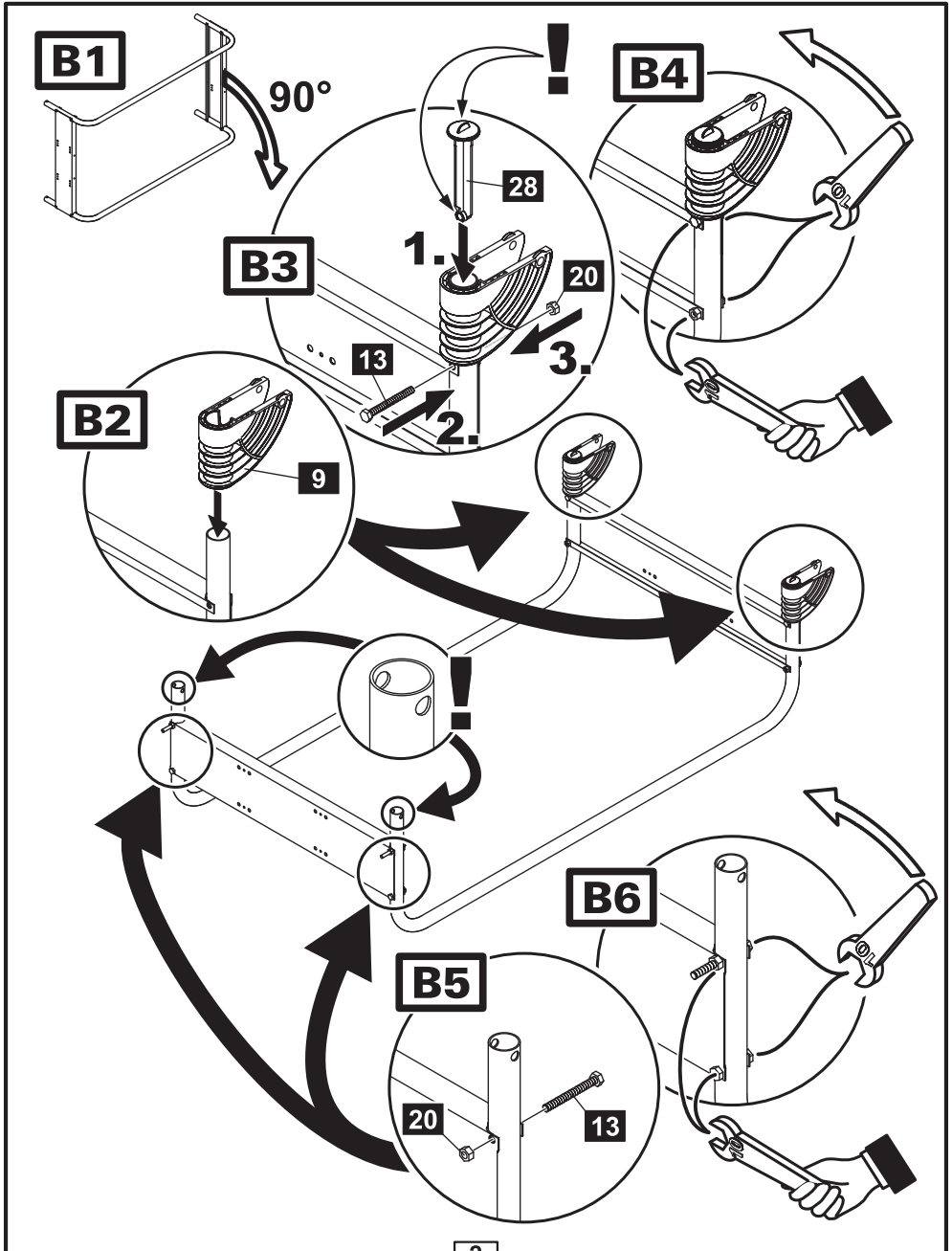
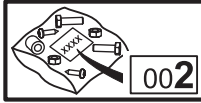
B

C

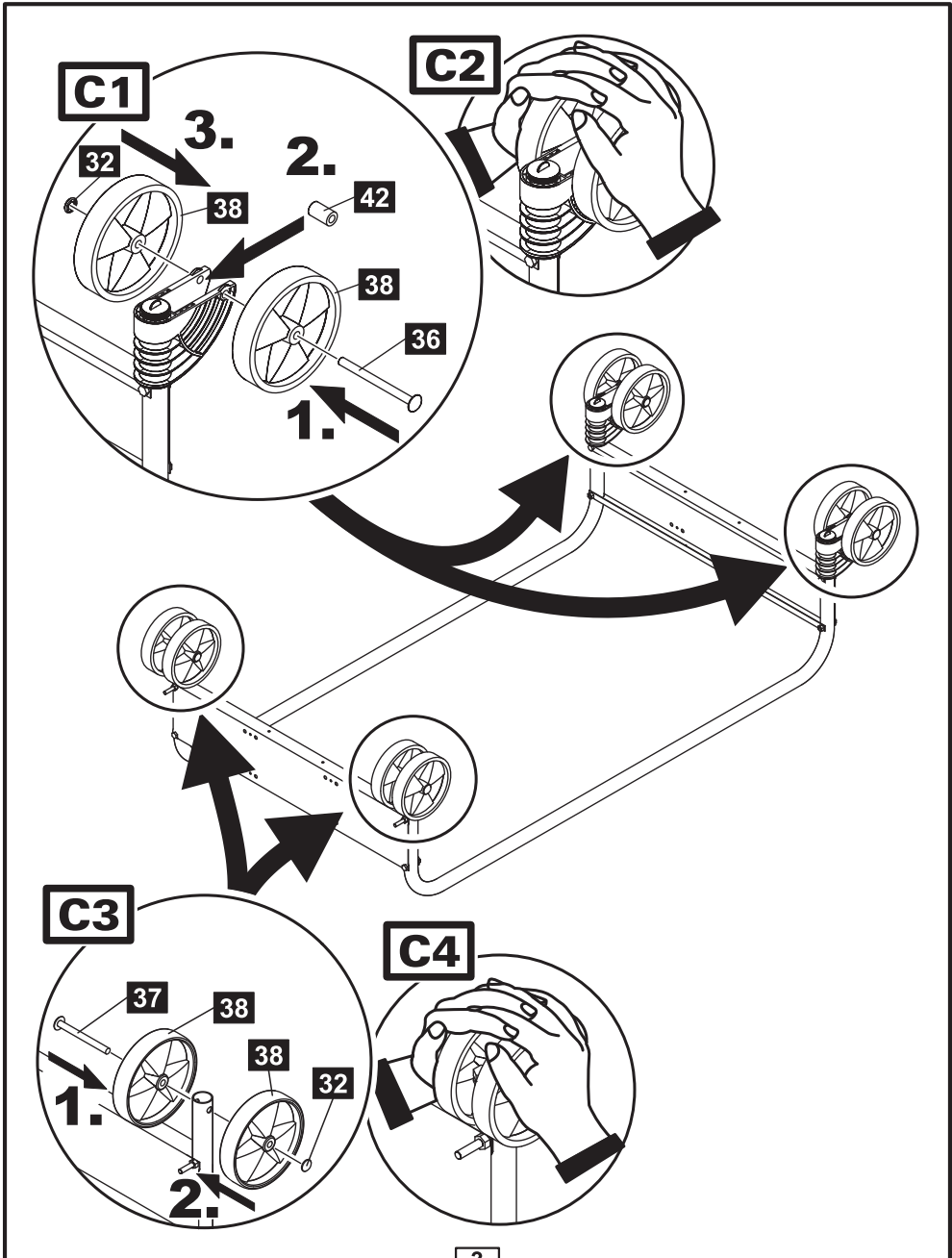
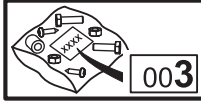

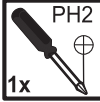
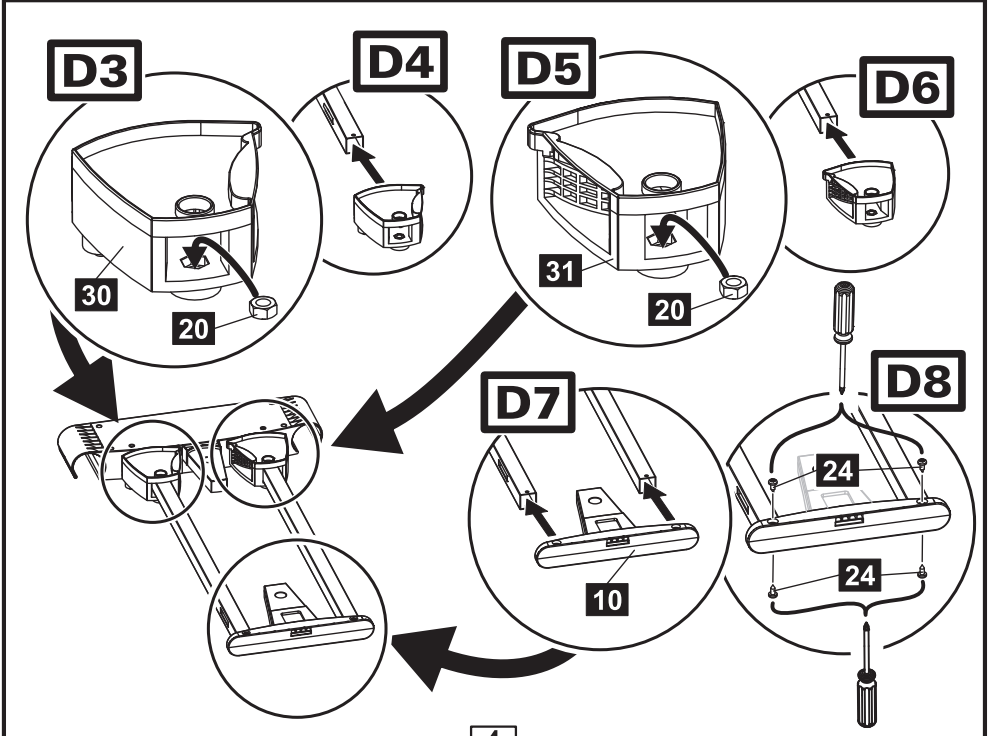
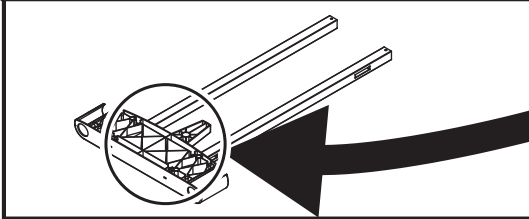
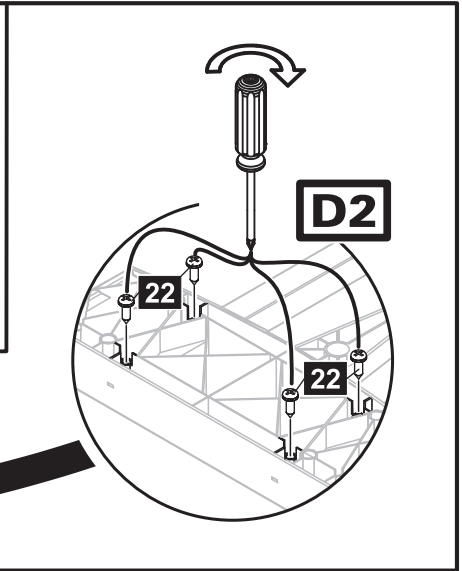
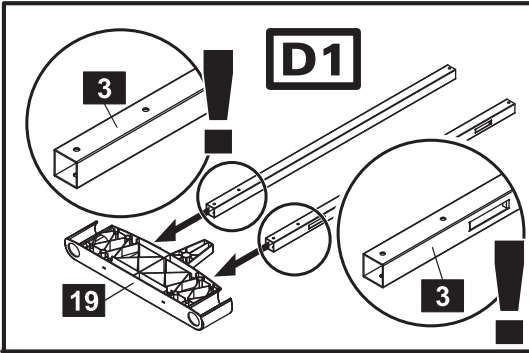
D**2x**

E

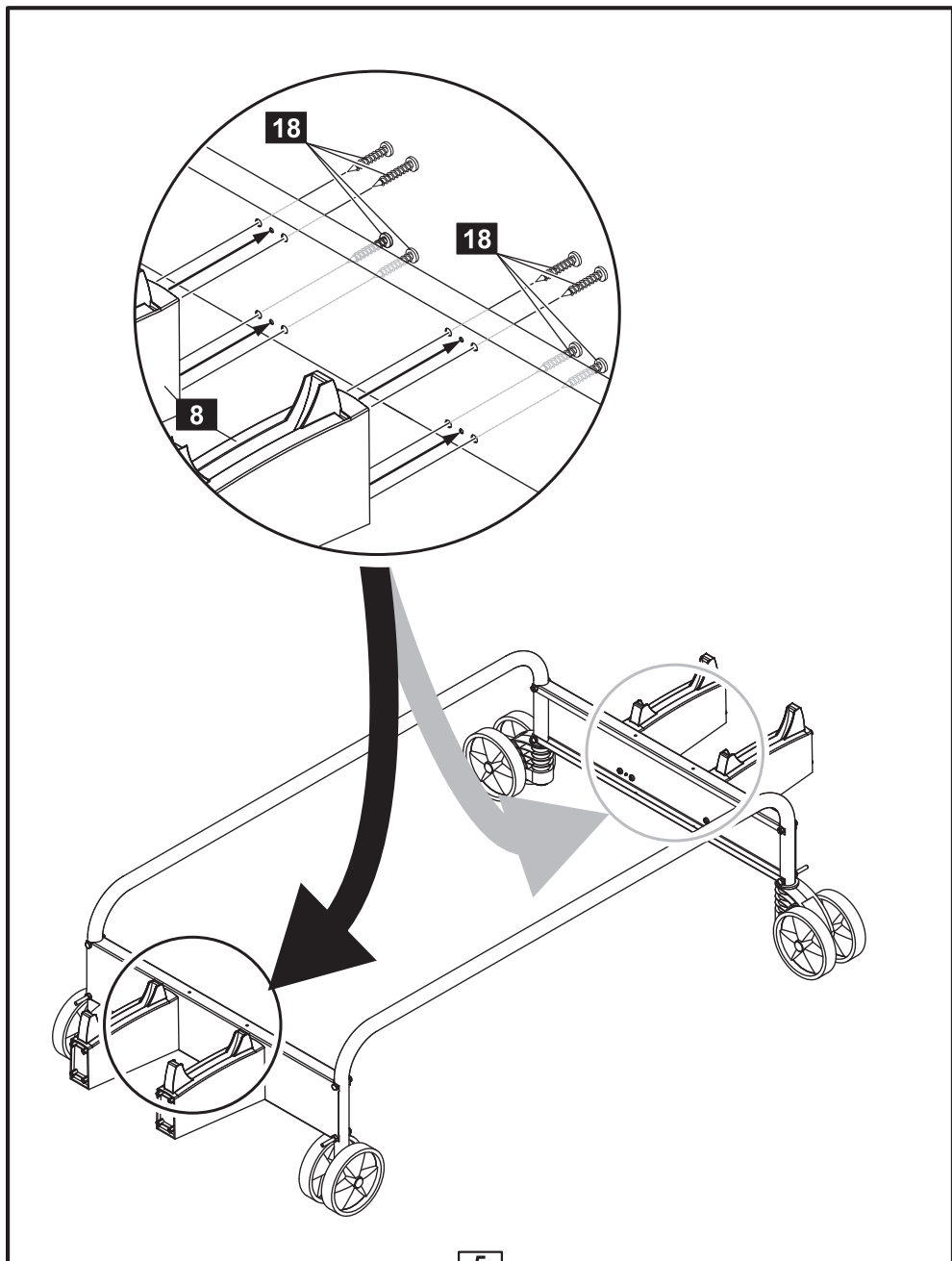
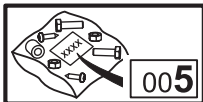

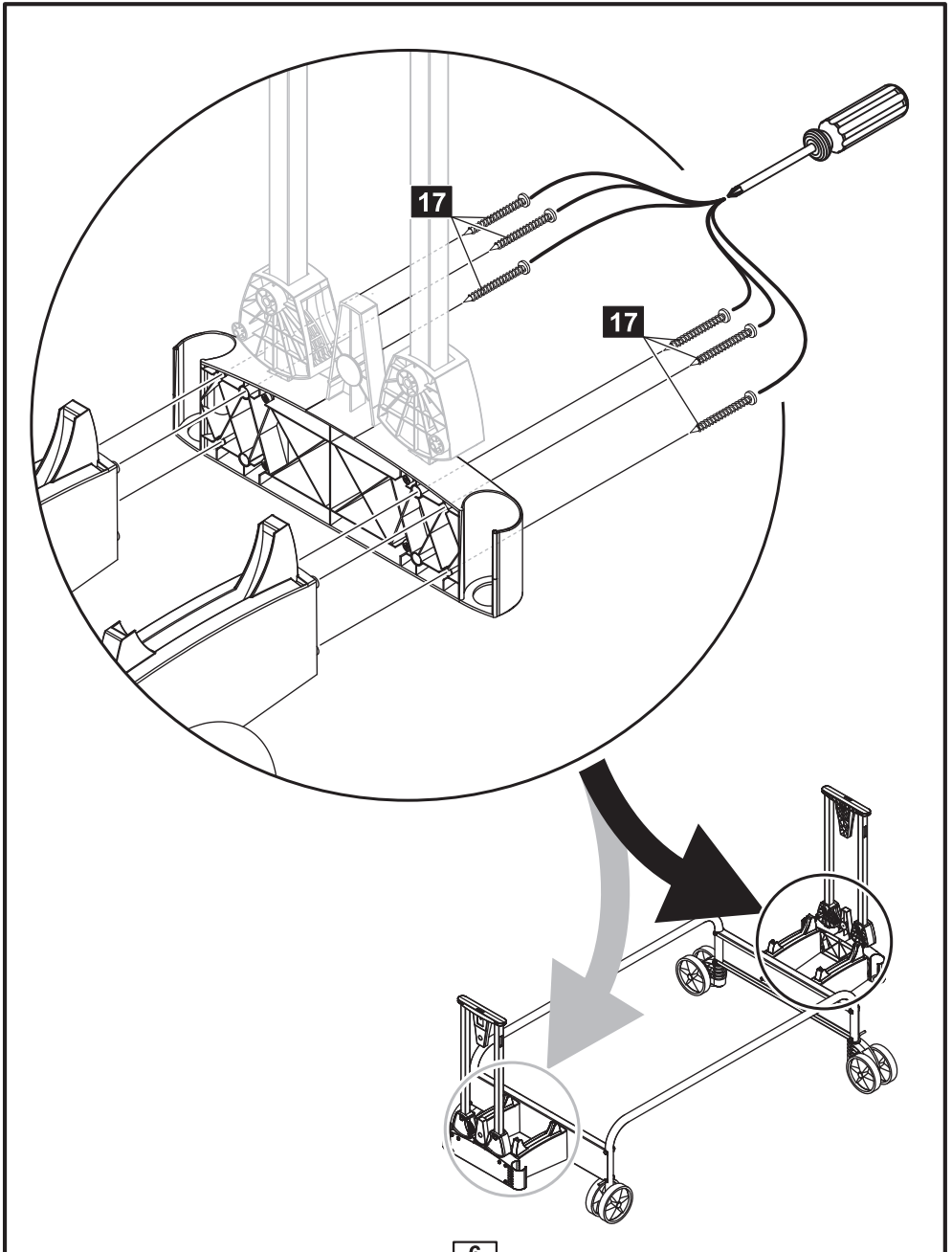
F

G

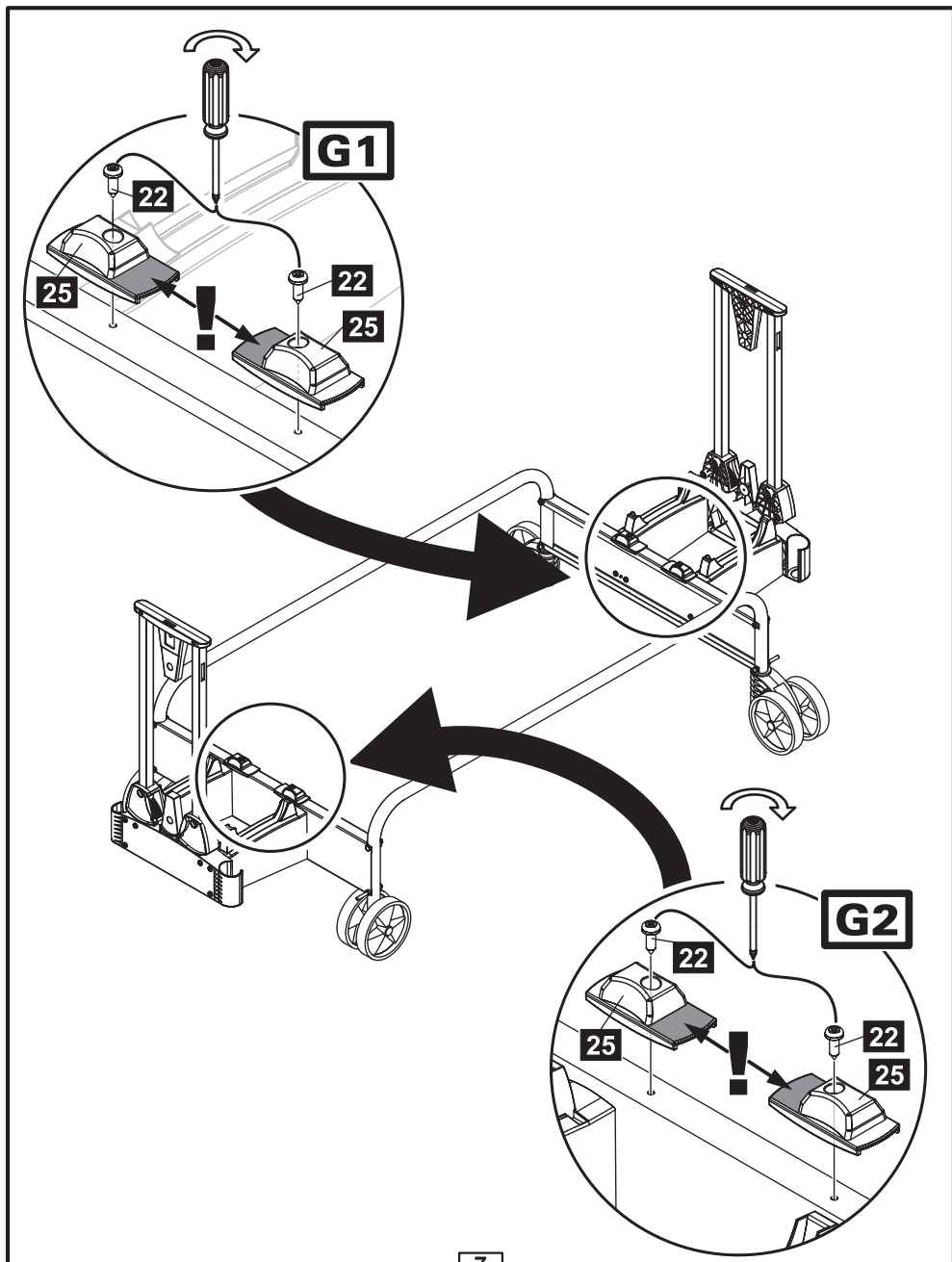
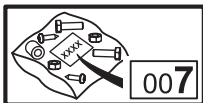

H



2x

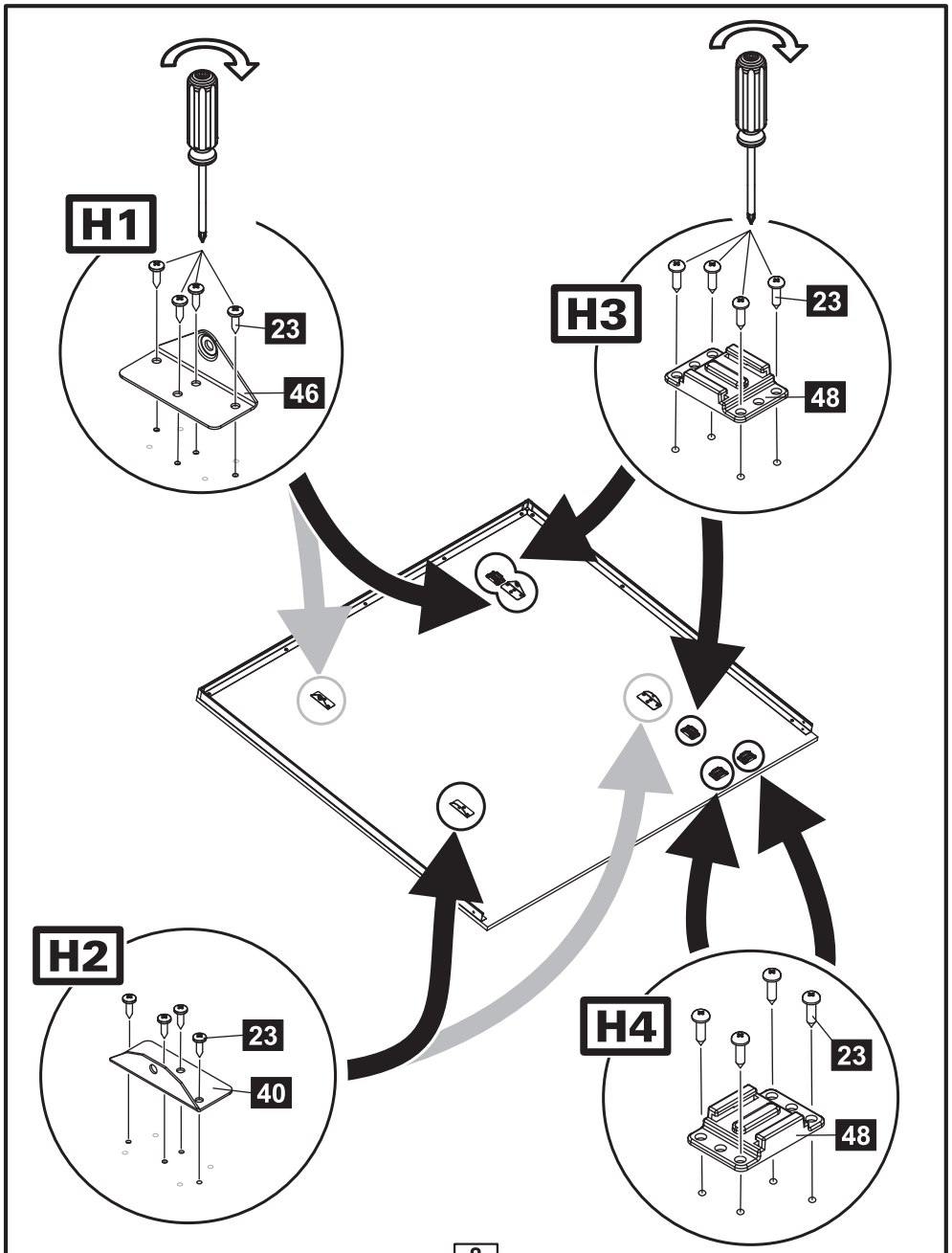

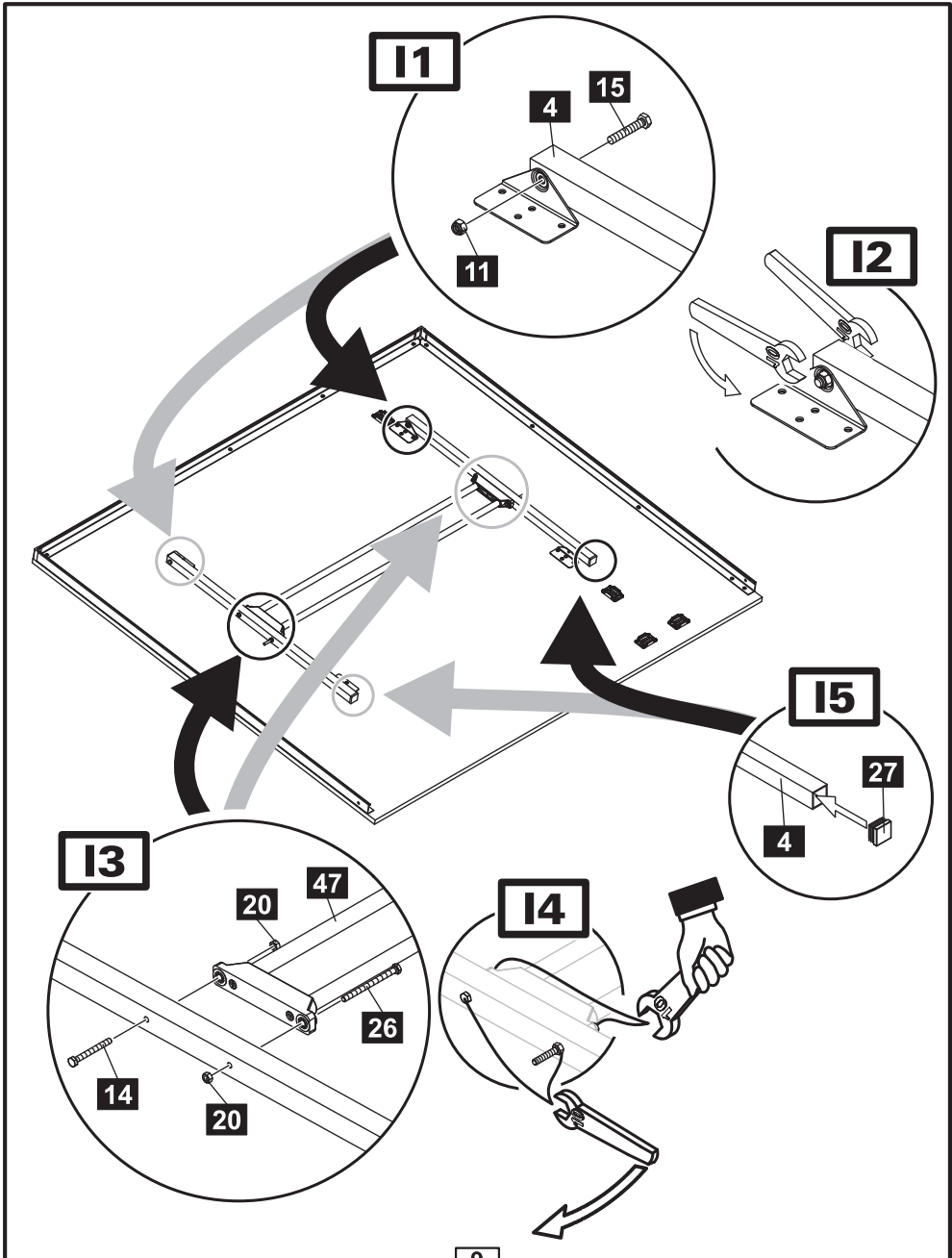

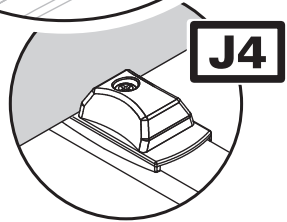
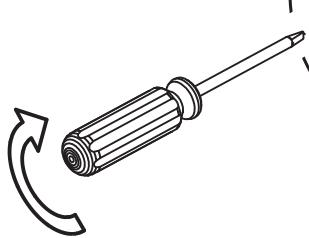
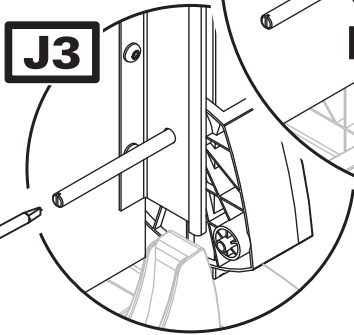
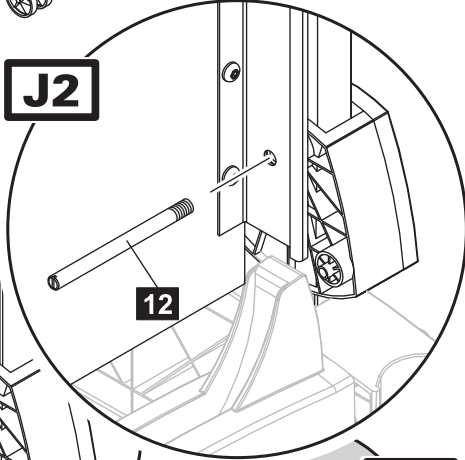
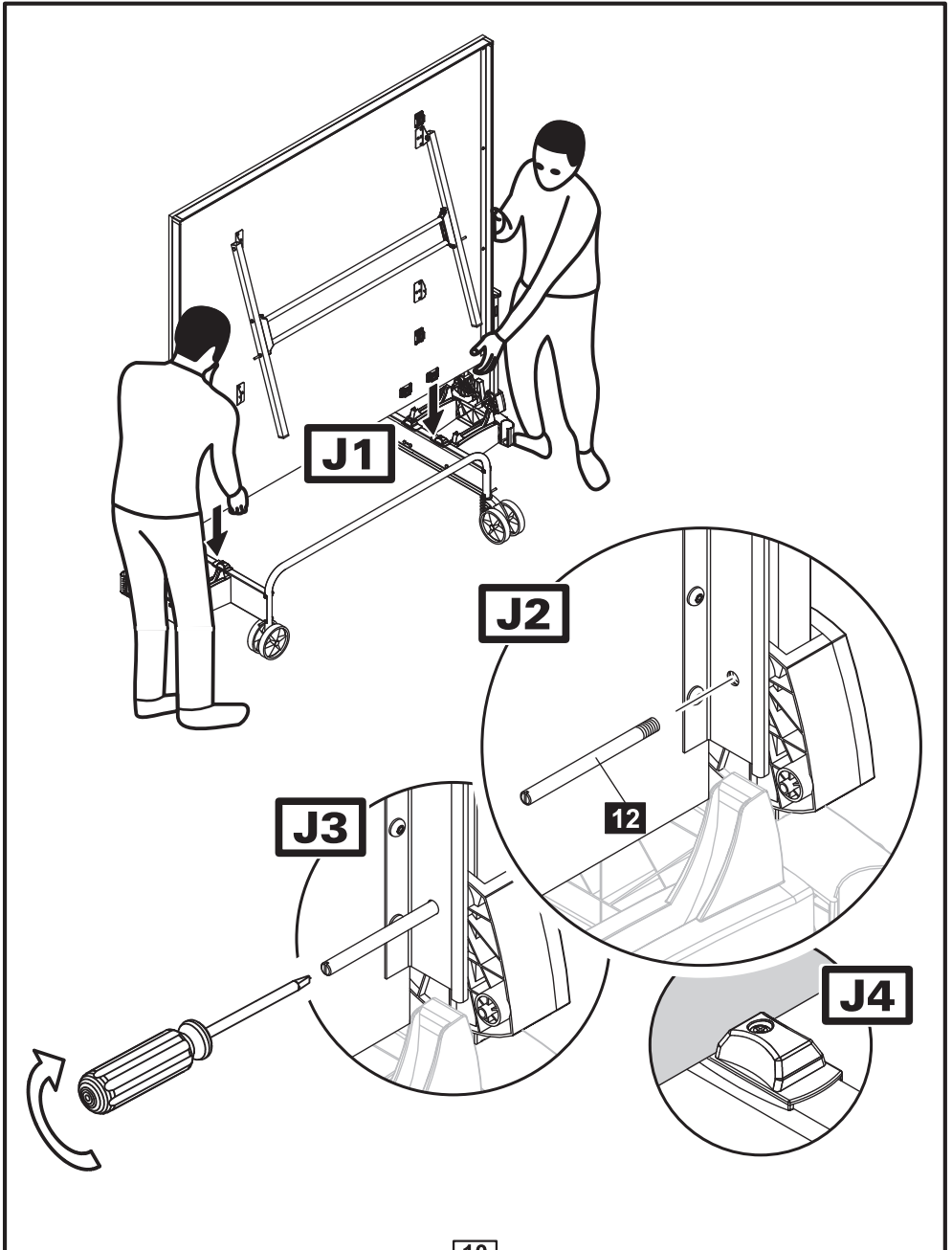
J

K

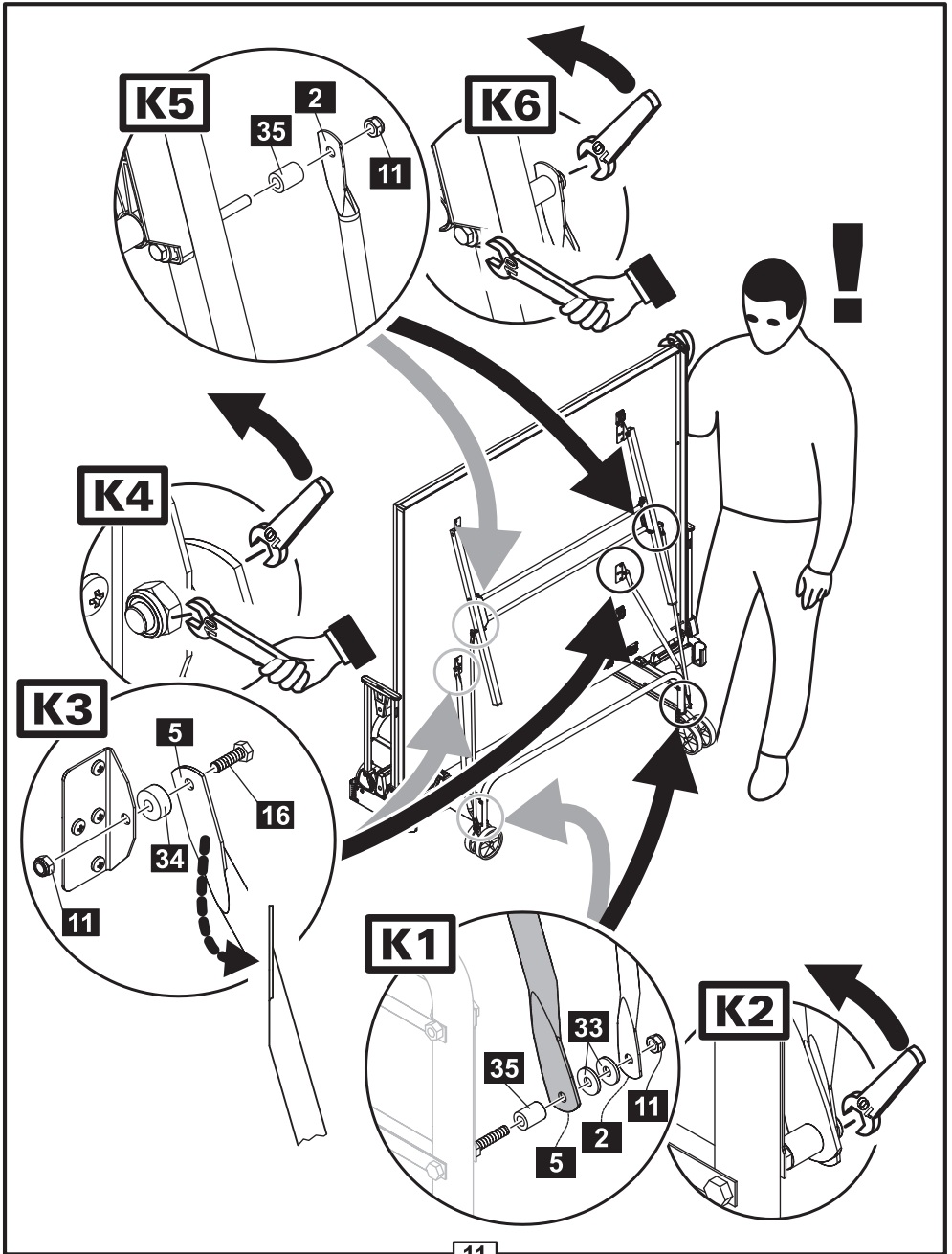

L

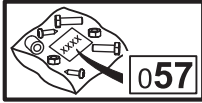

2x

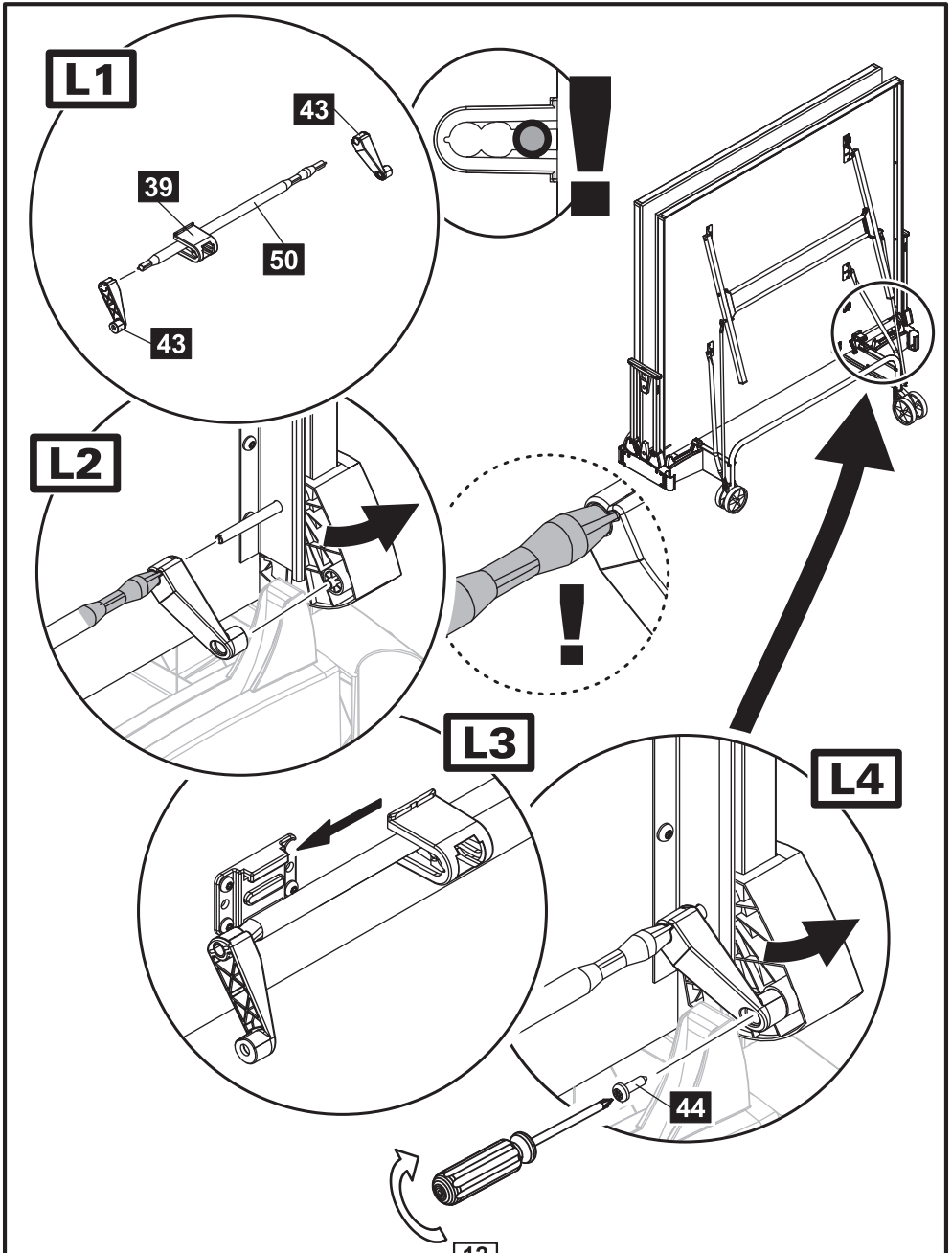

L1

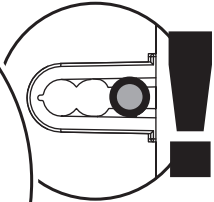
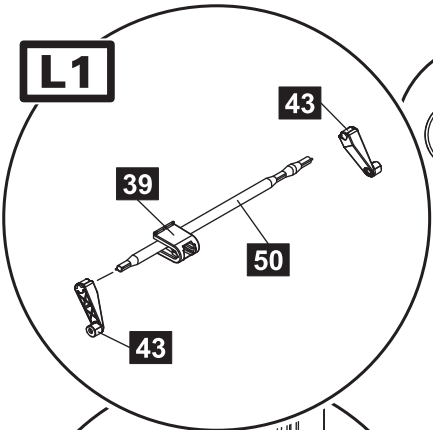

L2

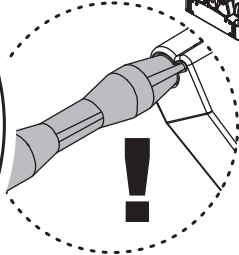
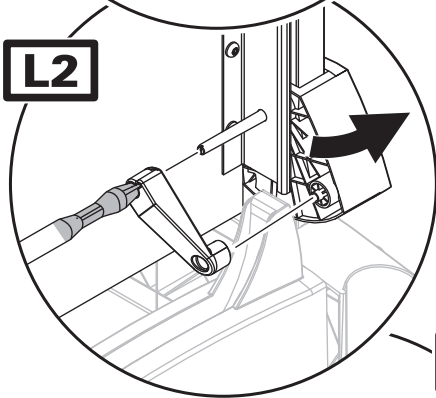

L3

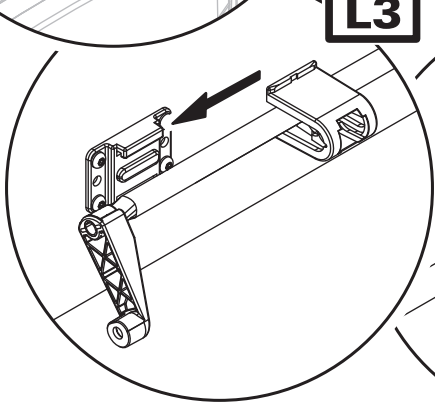

L4

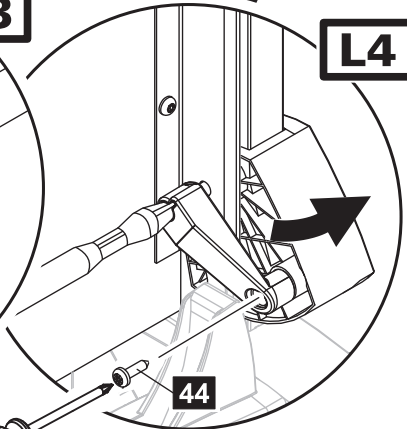

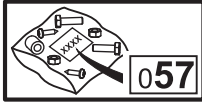
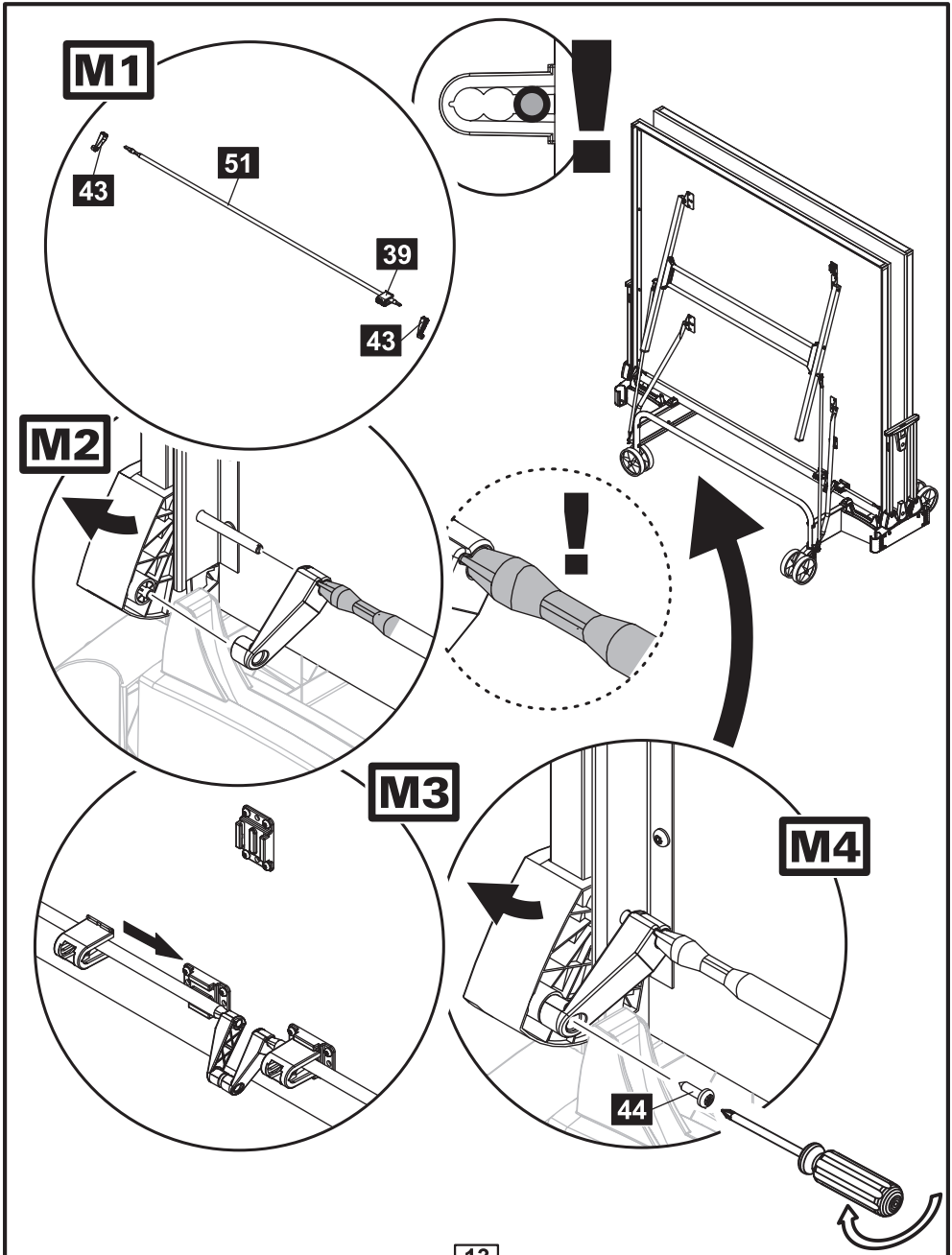
M**2x**

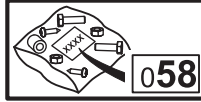
N**2x**